

PHILIPS

HD2137

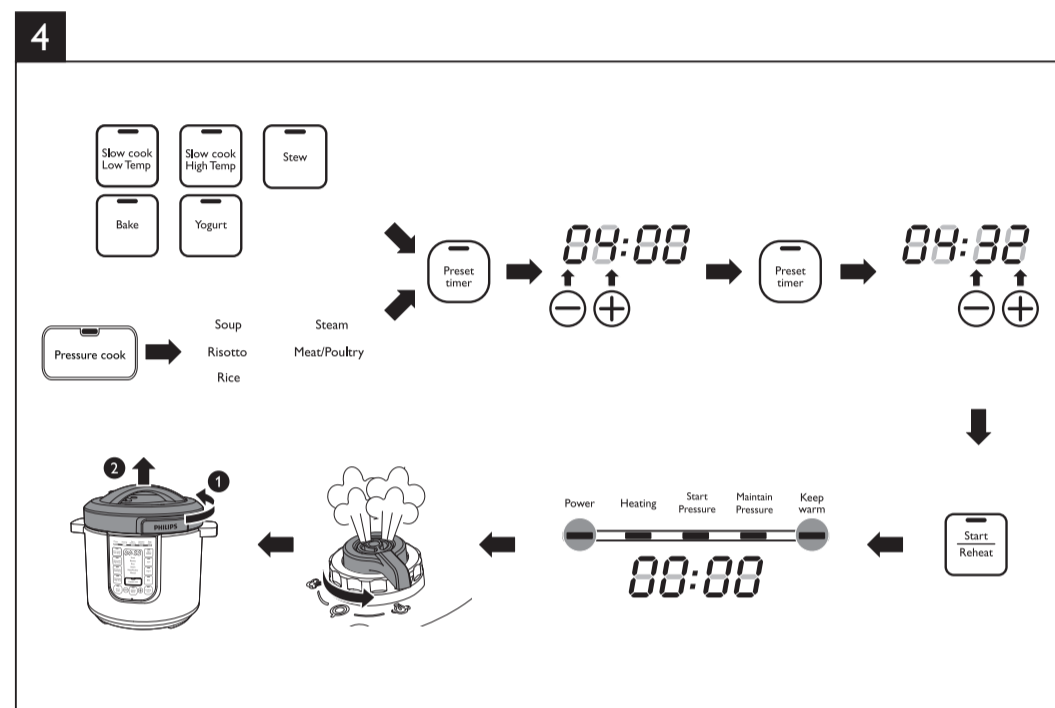

User manual

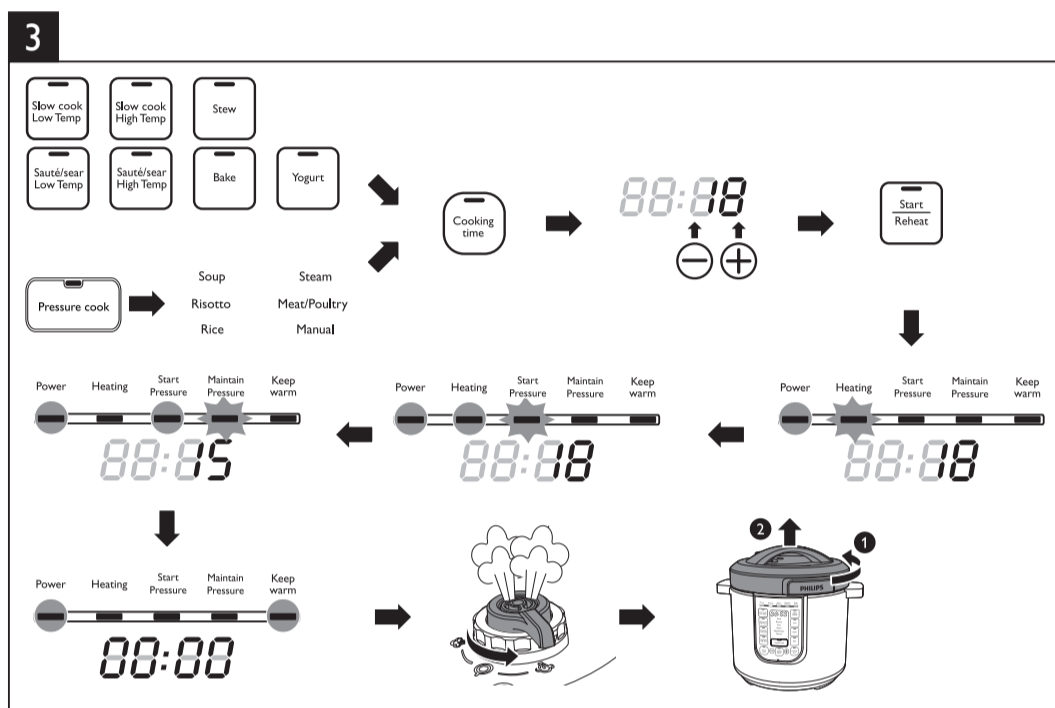
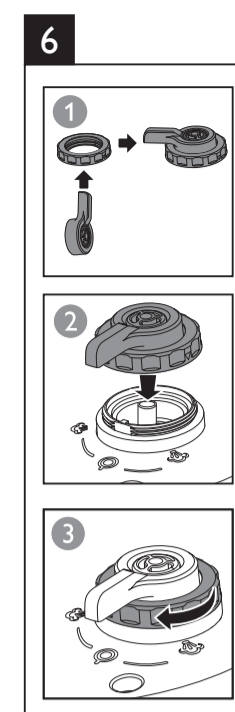
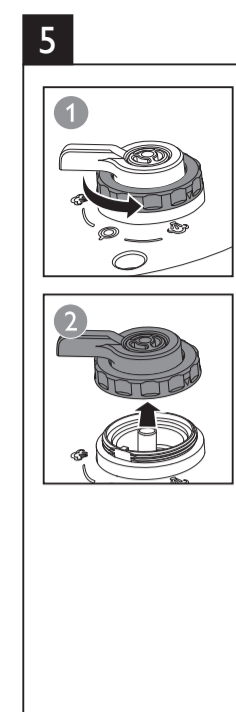
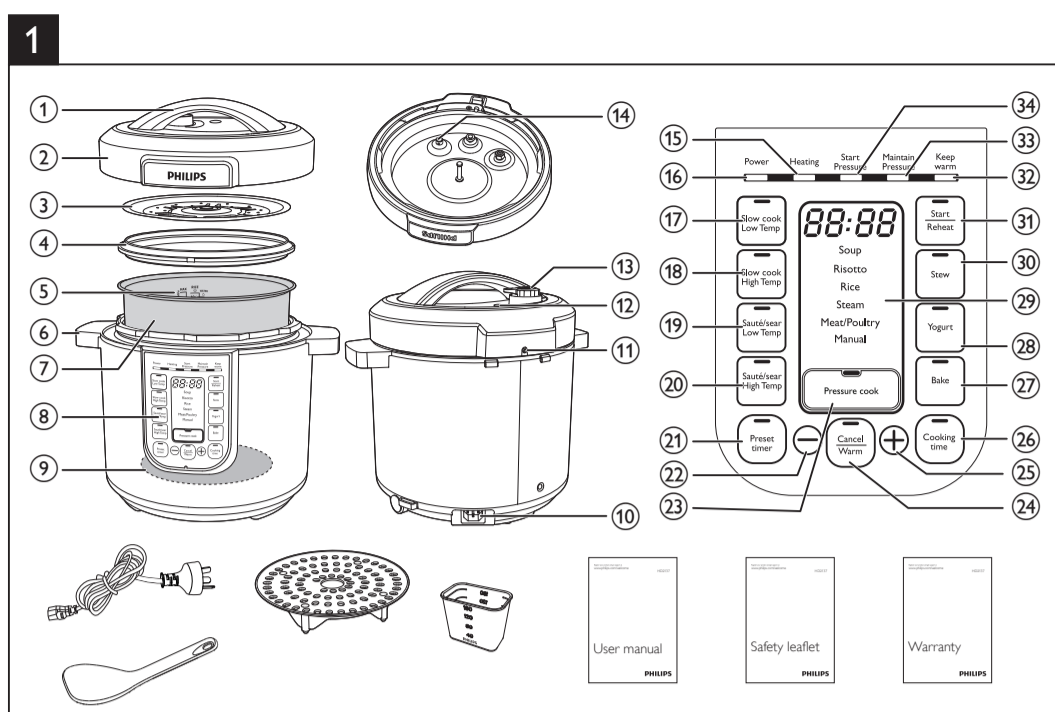

- Do not use the appliance if too much air or steam is leaking from under the top lid.
- When cooking soup or viscous liquid, do not release pressure by turning the pressure regulator to the steam vent position, otherwise liquid might spurt from the pressure regulator valve. Wait until the pressure is naturally released and the floater has dropped to open the top lid.

Caution

- Never use any accessories or parts from other manufacturers or that Philips does not specifically recommend. If you use such accessories or parts, your guarantee becomes invalid.
- Do not expose the appliance to high temperatures, nor place it on a working or still hot stove or cooker.
- Do not expose the appliance to direct sunlight.
- Place the appliance on a stable, horizontal, and level surface.
- Do not use the handle on the top lid to move the appliance, use the side handles instead.
- When pressure is being released from the pressure regulator valve, hot steam or liquid will be ejected. Keep hands and face away from the steam vent.
- Always put the inner pot in the appliance before you put the plug in the power outlet and switch it on.
- Do not place the inner pot directly over an open fire to cook food.

©2018 Koninklijke Philips N.V. All rights reserved. HD2137_UM_Aus_v7.0



English

1 Your electric pressure cooker

Congratulations on your purchase, and welcome to Philips! To fully benefit from the support that Philips offers, register your product at www.Philips.com/welcome.

2 Important

Safety

Read this user manual carefully before you use the appliance, and save it for future reference.

Danger

- The appliance must not be immersed.

Warning

- Check if the voltage indicated on the appliance corresponds to the local power voltage before you connect it.
- The appliance is intended to be used in household or similar applications such as:
 - staff kitchen areas in shops, offices, and other residential type environments;

- farm houses;
- by clients in hotels, motels and other residential type environments;
- bed and breakfast type environments.
- This appliance is not intended for use by persons (including children) with reduced physical, sensory or mental capabilities, or lack of experience and knowledge, unless they have been given supervision or instruction concerning use of the appliance by a person responsible for their safety.
- Children should be supervised to ensure that they do not play with the appliance.
- If the supply cord is damaged, it must be replaced by the manufacturer, its service agent or similarly qualified persons in order to avoid a hazard.
- The appliance is not intended to be operated by means of an external timer or a separate remote-control system.
- The ducts in the pressure regulator allowing the escape of steam should be checked to ensure that they are not blocked.
- The container must not be opened until the pressure has decreased sufficiently.
- Cleaning and user maintenance shall not be made by children.

- Keep the appliance and its cord out of reach of children.
- WARNING:** Always follow the instructions and use the appliance properly to avoid potential injury.
- WARNING:** Make sure to avoid spillage on the power connector to avoid a potential hazard.
- CAUTION:** Surface of the heating element is subject to residual heat after use.
- Use clean and soft cloth to clean the surfaces in contact with food.
- Only connect the appliance to a grounded power outlet. Always make sure that the plug is inserted firmly into the power outlet.
- Do not use the appliance if the plug, the power cord, the inner pot, the sealing ring, or the main body is damaged.
- Do not let the power cord hang over the edge of the table or worktop on which the appliance stands.
- Make sure the heating element, the temperature sensor, and the outside of the inner pot are clean and dry before you put the plug in the power outlet.
- Do not plug in the appliance or turn the control knob with wet hands.
- Make sure the power socket is clean and dry before you plug in the appliance.

- Do not use the inner pot if it is deformed.
- Make sure that the sealing ring is clean and in good condition.
- The accessible surfaces may become hot when the appliance is operating. Take extra caution when touching the surfaces.
- Beware of hot steam coming out of the floating valve and pressure regulator valve during cooking or when you open the lid. Keep hands and face away from the appliance to avoid the steam.
- Do not lift and move the appliance while it is operating.
- Do not exceed the maximum water level indicated in the inner pot to prevent overflow.
- Do not place the cooking utensils inside the pot while cooking.
- Only use the cooking utensils provided. Avoid using sharp utensils.
- To avoid scratches, it is not recommended to cook ingredients with crustaceans and shellfish. Remove the hard shells before cooking.
- Do not place a magnetic substance on the lid. Do not use the appliance near a magnetic substance.
- Always let the appliance cool down to room temperature before you clean or move it.
- Always clean the appliance after use. Do not clean the appliance in dishwasher.
- Always unplug the appliance if not used for a longer period.

- If the appliance is used improperly or for professional or semi-professional purposes, or if it is not used according to the instructions in this safety leaflet, the guarantee becomes invalid and Philips refuses liability for any damage caused.
- Visit www.philips.com/support to download the user manual.

Electromagnetic fields (EMF)

This Philips appliance complies with all applicable standards and regulations regarding exposure to electromagnetic fields.

2 What's in the box (fig. 1)

Main unit	Power cord
Rice & Soup ladle	Steaming plate
Measuring cup	Safety leaflet
User manual	Recipe booklet
Warranty card	

3 Overview (fig. 1)

Product overview

① Lid handle	⑧ Control Panel
② Top lid	⑨ Heating element
③ Detachable inner lid	⑩ Power socket
④ Sealing ring	⑪ Locking pin
⑤ Water level indications	⑫ Floater
⑥ Side handle	⑬ Pressure regulator
⑦ Inner pot	⑭ Safety valve

Controls overview

⑮ Heating indicator	⑲ Increase button
⑯ Power indicator	⑳ Cooking time button
⑰ Slow cook button (low temperature)	㉑ Bake button
⑰ Slow cook button (high temperature)	㉒ Yogurt button
⑱ Sauté/sear button (low temperature)	㉓ Display screen
⑳ Sauté/sear button (high temperature)	㉔ Stew button
㉕ Preset timer button	㉖ Start/Reheat button
㉗ Decrease button	㉘ Keep warm indicator
㉙ Pressure cook button	㉚ Maintain pressure indicator
㉛ Cancel/Warm button	㉜ Start pressure indicator

Functions overview

Pressure cooking functions		
Cooking function	Default pressure keeping time (minute)	Pressure keeping time regulating range (minute)
Soup	20	20-59
Risotto	14	Not adjustable
Rice	14	Not adjustable
Steam	10	5-59
Meat/Poultry	15	12-59
Manual	2	2-59
Normal cooking functions		
Cooking function	Default cooking time	Cooking time regulating range
Slow cook (low temperature)	6 hours	2 - 12 hours
Slow cook (high temperature)	6 hours	2 - 12 hours
Sauté/sear (low temperature)	2 minutes	2 minutes - 2 hours
Sauté/sear (high temperature)	2 minutes	2 minutes - 2 hours
Stew	1 hour	20 minutes - 10 hours
Yogurt	8 hours	6 - 12 hours
Bake	45 minutes	10 - 59 minutes
Reheat	25 minutes	8 - 25 minutes

4 Using the electric pressure cooker

Before first use

- Remove all packaging materials from the appliance.
- Take out all the accessories from the inner pot.
- Clean the parts of the electric pressure cooker thoroughly before using it for the first time (see chapter "Cleaning and Maintenance").

Note

- Make sure all parts are completely dry before you start using the electric pressure cooker.

Preparations before cooking (fig. 2)

Before using the electric pressure cooker to cook food, follow below preparation steps:

- Hold the lid handle and turn it anti-clockwise until the top lid cannot move any more, then lift up the top lid.
- Take out the inner pot from the electric pressure cooker and put the pre-washed food in the inner pot.
- Wipe the outside of the inner pot dry, then put it back into the electric pressure cooker.
- Place the top lid onto the electric pressure cooker and turn it clockwise. You will hear a "click" sound when the top lid is properly locked.

Note

- Make sure the sealing ring is properly assembled around the edge of the detachable inner lid.
- Make sure the pressure regulator valve and floating valve are clean and not blocked.
- Make sure the outside of the inner pot is dry and clean, and that there is no foreign residue on the heating element.
- Make sure the inner pot is in proper contact with the heating element.

Cooking food (fig. 3)

Note

- Do not fill the inner pot with less than 1/3 or more than 2/3 full of food and liquid.
- For food that expands during cooking, do not fill the inner pot with more than 1/2 full of food and liquid.
- For rice cooking, follow the water level indications on the inside of the inner pot. You can adjust the water level for different types of rice and according to your own preference. Do not exceed the maximum quantities indicated on the inside of the inner pot.
- Make sure the floater on the top lid drops down before cooking.
- After the cooking process is started, you can press **Cancel/Warm** to deactivate the current work, and the appliance goes to standby mode.

Pressure cooking

- Follow the steps in "Preparations before cooking".
- Turn the pressure regulator to **seal**.
- Put the plug in the power socket.
 - ↳ The power indicator starts flashing.
- Press **Pressure cook** to choose one of the pressure cooking functions - **Soup, Risotto, Rice, Steam, Meat/Poultry** or **Manual**.
 - ↳ The default pressure keeping time is displayed on the screen.

Note

- The pressure keeping time is not adjustable for **Risotto** and **Rice**.

- To set a different pressure keeping time, press **Cooking time**.
- Press **+** or **-** to set the pressure keeping time.
- Press **Start/Reheat** to start the cooking process.
- When the electric pressure cooker reaches the working pressure:
 - ↳ **Maintain Pressure** lights up;
- When the pressure keeping time has elapsed, the electric pressure cooker automatically switches to keep warm mode.
 - ↳ The keep warm indicator (**Keep warm**) lights up.
- Turn the pressure regulator to **vent**.
 - ↳ The electric pressure cooker starts releasing pressure.
 - ↳ The floater drops down when the pressure is released sufficiently.
- Hold the top lid handle and turn the lid anti-clockwise until it cannot move any more, then lift it up.

Note

- When cooking soup or viscous liquid, do not release pressure by turning the pressure regulator to **vent**, otherwise liquid might spurt from the pressure regulator valve. Wait until the pressure is naturally released and the floater has dropped down to open the top lid.
- The pressure keeping timer will start counting down when the working pressure is reached.
- After the cooking is finished and the pressure is released, you can press the cancel button (**Warm/Cancel**) and unplug the electric pressure cooker to turn off the keep warm function or when not in use.

Normal cooking

Note

- For normal cooking, you can cook food without adding water in the inner pot. In this case, make sure to turn the pressure regulator to **bake**.
- Make sure to keep the top lid open for the entire time when you cook food in the **Sauté/sear** mode.
- To choose the **Reheat** function, press **Start/Reheat** when the appliance is in standby mode.

To cook food with normal pressure, press the cooking buttons and choose **Slow cook, Sauté/sear, Stew, Yogurt** or **Bake**.

- Follow the steps in "Preparations before cooking".
- Turn the pressure regulator to **bake** or **seal**.
 - For **Slow cook, Stew** and **Yogurt**, turn the pressure regulator to **seal**.
 - For **Bake**, turn the perssure regulator to **bake**.
- Put the plug in the power socket.
 - ↳ The power indicator (**Power**) starts flashing.
- Press the desired cooking function button to choose a cooking mode.
- To set a different cooking time, press **Cooking time**.
 - ↳ The cooking time flashes on the screen.
- Press **+** or **-** to set the cooking time.
- Press **Start/Reheat** to start the cooking process.
- When the cooking time has elapsed, the electric pressure cooker automatically switches to keep warm or standby mode.
- Turn the pressure regulator to **vent**.
- Hold the top lid handle and turn the lid anti-clockwise until it cannot move any more, then lift it up.

Baking recipe

Apple cake with hazelnuts

Ingredients:

- 190g margarine
- 190g flour
- 200g sugar
- 3/4 tsp.baking powder
- Cinnamon
- 100g almond meal
- 2 medium eggs
- 80ml of maple syrup
- 2 medium apples, peeled, cored and cut into eights.

- Mix the margarine with sugar, add the eggs and mix thoroughly. Add the flour, baking powder and almond meal, mix until the mixture is creamy. Fold with maple syrups.
- Grease the base and slides of the inner pot, add the mixture and smooth the top of mixture to create level finish. Place the apples on top, pushing them slightly into the mixture. Sprinkle with cinnamon.
- Press **Bake**, set cooking time for 50 minutes and press **Start/Reheat**. Close the lid.

Preset time for delayed cooking (fig.4)

You can preset the delayed cooking time for different cooking functions. The preset timer is available up to 24 hours.

- After the cooking function is selected, press **Preset timer**.
 - ↳ The hour unit starts flashing on the display.
- Press **+** or **-** to set the hour unit.
- After the hour unit is set, press **Preset timer** again.
 - ↳ The minute unit starts flashing on the display.
- Press **+** or **-** to set the minute button.
- Press **Preset timer** to confirm the preset time.
- Press **Start/Reheat** to start the cooking process.
- When the preset time has elapsed, the electric pressure cooker starts working automatically.

Note

- The preset function is not available in the following modes: **Sauté/Sear** (both low and high temperatures), **Reheat, Manual** and **Warm**.

Assembling and disassembling the pressure regulator

Warning

- Do not disassemble the pressure regulator during cooking. Always unplug the electric pressure cooker and wait until the pressure has been released sufficiently to do so.

- To disassemble the pressure regulator:

- Turn the lower screw anticlockwise until it becomes loose.
- Pull it up and take out the pressure regulator.
- To assemble the pressure regulator:
 - Assemble the lower screw back to the regulator.
 - Make sure the regulator points at the sealed position (☉) and put it back to the steam valve.
 - Turn the screw clockwise until it is fastened.

5 Cleaning and Maintenance

Note

- Unplug the electric pressure cooker before starting to clean it.
- Wait until the electric pressure cooker has cooled down sufficiently before cleaning it.

Interior

Inside of the top lid and the main body:

- Wipe with wrung out and damp cloth.
 - Make sure to remove all the food residues stuck to the electric pressure cooker.

Heating element:

- Wipe with wrung out and damp cloth.
- Remove food residues with wrung out and damp cloth.

Sealing ring:

- Soak in warm water and clean with sponge.

Inner lid:

- Remove the detachable inner lid. Soak it in warm water and clean with sponge.

9 Troubleshooting

If your electric pressure cooker does not function properly or if the cooking quality is insufficient, consult the table below. If you are unable to solve the problem, contact a Philips service center or the Consumer Care Center in your country.

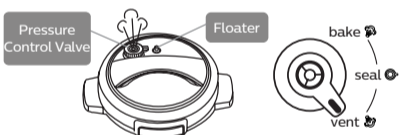
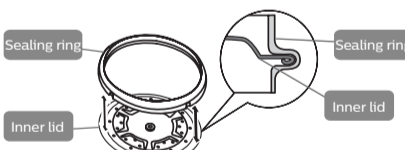
Problem	Cause	Solution
I have difficulties opening the lid after cooking.	Need to release the pressure.	 Set the pressure control valve to 'Vent'. And wait until the floater has dropped.
	Floater stuck in up position.	Set the pressure control valve to 'Vent'. And wait until the floater has dropped.
I have difficulties closing the top lid.	The sealing ring is not well assembled.	Make sure the sealing ring is well assembled around the inside of the top lid.
	The floater stuck in up position.	The floater blocks the locking pin. Push down the floater so that it does not block the locking pin.
Leaking from under lid.	Sealing ring missing.	 Put sealing ring in place correctly on inner lid.
	Food or debris under sealing ring. Lid not correctly closed.	Remove the sealing ring, clean and replace. Open and reclose the lid, checking for correct closing.
Leaking from floater	The pressure level inside of the appliance is abnormal.	In this case the safety valve will be releasing steam. Take the appliance to your Philips dealer or a service center authorized by Philips.
	Sealing ring broken.	Replace the sealing ring.
Floater does not rise up after the appliance starts pressurizing.	Food or debris under sealing ring.	Remove the sealing ring, clean and replace.
	Food&water are below minimum level.	Add food/water. Make sure there is enough food and water in the inner pot.
E3 displays on the screen.	Leaking from lid or pressure control valve.	Take the appliance to a Philips service dealer.
	The temperature inside the inner pot is too high.	Wait until it falls down to room temperature.
E1, E2, or E4 displays on the screen.	The electric pressure cooker has malfunction.	Take the appliance to a Philips service center.

Exterior

Surface of the top lid and outside of the main body:

- Wipe with a cloth damped with soap water.
- Only use soft and dry cloth to wipe the control panel.
- Make sure to remove all the food residues around the pressure regulator valve and floating valve.

Pressure regulator valve and floating valve:

- Disassemble the pressure regulator, soak it in warm water, and clean with sponge.
- Remove food residues in the pressure regulator valve and floating valve.

Accessories

Measuring cup, rice spoon, soup ladle, and inner pot:

- Soak in hot water and clean with sponge.

6 Specifications

Model Number	HD2137
Rated power output	1000W
Rated capacity	6.0L
Warm keeping temperature	60-80°C

Note

- Always unplug the appliance if not used for a longer period.

7 Environment

Do not throw away the product with the normal household waste at the end of its life, but hand it in at an official collection point for recycling. By doing this, you help to preserve the environment. Follow your country's rules for the separate collection of electrical and electronic products. Correct disposal helps prevent negative consequences for the environment and human health.

8 Guarantee and service

If you need service or information, or if you have a problem, visit the Philips website at www.philips.com or contact the Philips Customer Care Center in your country. You can find its phone number in the worldwide guarantee leaflet. If there is no Customer Care Center in your country, go to your local Philips dealer.